

## ORDER REFERENCE

PROJECT: UC601 CABLE DRUM 1000 LB.  
TYPICAL LAYOUT

PLEASE REFER TO PAGE 7  
OF THE PLANNING GUIDE FOR  
ADDITIONAL SIZING OPTIONS

1000 LB. WINDING DRUM  
OFFERS A MAXIMUM OF:  
6 STOPS  
50' OF TRAVEL  
15 SQ. FT. CAB SIZE

## SPECIFICATIONS

DRIVE: UC601 CABLE DRUM

CAPACITY: 1000#

LANDINGS: 3

CODE(S): 4

SPEED: AT 38 F.P.M.  $\pm 2$

SUSPENSION (2) STEEL WIRE ROPES 12,100#  
MEANS: BREAKING STRENGTH  $\phi 3/8 - 8 \times 19$  IWRC

CAR STYLE: 200 STYLE

CAR CONSTRUCTION: 3/4" HARDWOOD VENEER

NOTE: ALL MANUFACTURER SUPPLIED CAR AND EQUIPMENT OPTIONS ARE NOTED ON THE CONFIRMING ORDER SHEET.

DISCLAIMER: ONCE DRAWINGS HAVE BEEN APPROVED, SIGNED AND WITHIN 5 DAYS OF PRODUCTION, THE CUSTOMER WILL BEAR ALL RESPONSIBILITY AND LIABILITY OF FINISHED UNIT.

DWG VIEW COVER SHEET		PART NUMBER 80205323			REV. DATE 11/21/19	
DRAWING TITLE TYPICAL UC601 CABLE DRUM 1000		DRAWING NO. TYP-WD1000-021			-	
PAGE: 1/5	DRAWN BY: J. PETTYJOHN	DWG. DATE 3/2017	JOB OR APP.# -	DEALER P.O.# -	DWG. SCALE 1:24	REV. LEVEL(1-3) A

TYPICAL DRAWING  
NOT TO BE USED FOR CONSTRUCTION

TYPICAL DRAWING  
NOT TO BE USED FOR CONSTRUCTION

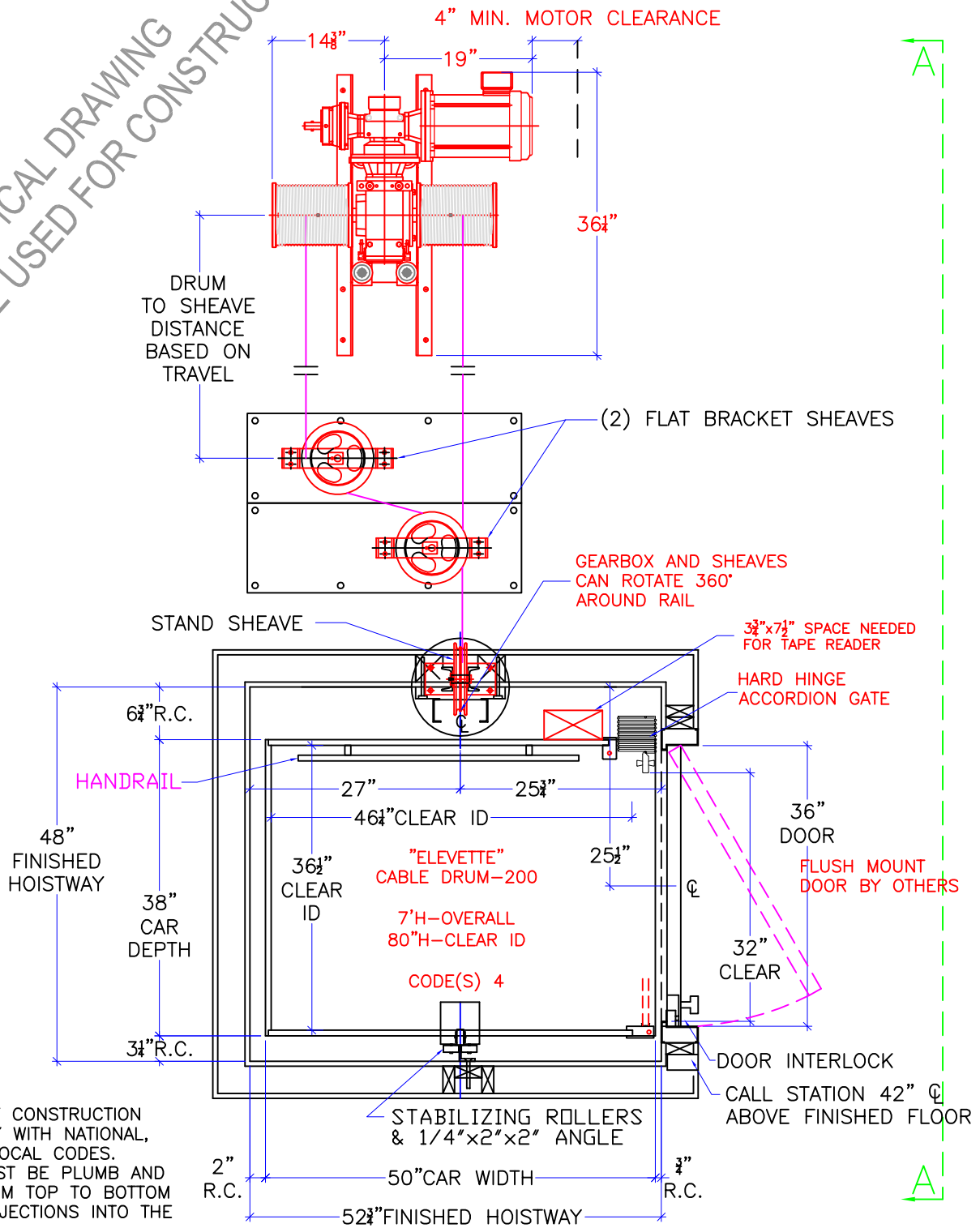

NOTE:  
ALL HOISTWAY CONSTRUCTION MUST COMPLY WITH NATIONAL, STATE, AND LOCAL CODES. HOISTWAY MUST BE PLUMB AND STRAIGHT FROM TOP TO BOTTOM WITH NO PROJECTIONS INTO THE HOISTWAY.

DWG VIEW HOISTWAY LAYOUT		PART NUMBER 80205323		REV. DATE 11/21/19	
DRAWING TITLE TYPICAL UC601 CABLE DRUM 1000		DRAWING NO. TYP-WD1000-021		REV. LEVEL(1-3) -	
PAGE: 2/5	DRAWN BY: J. PETTYJOHN	DWG. DATE 3/2017	JOB OR APP.# -	DEALER P.O.# -	DWG. SCALE 1:24



TYPICAL DRAWING  
NOT TO BE USED FOR CONSTRUCTION

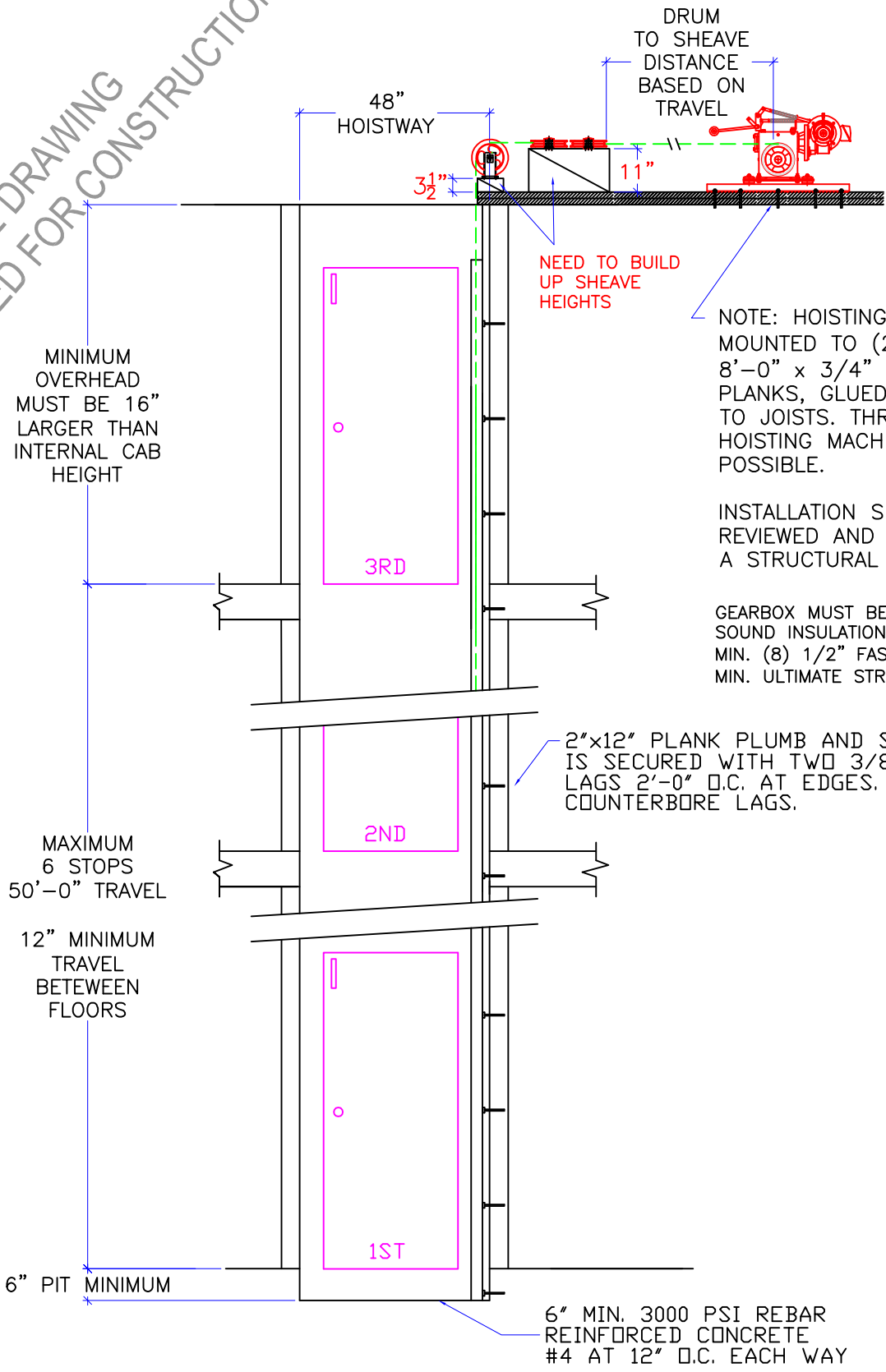

DWG VIEW		PART NUMBER		REV. DATE		
SECTION A-A		80205323		11/21/19		
DRAWING TITLE		DRAWING NO.		-		
TYPICAL UC601 CABLE DRUM 1000		TYP-WD1000-021		-		
PAGE:	DRAWN BY:	DWG. DATE	JOB OR APP.#	DEALER P.O.#	DWG. SCALE	REV. LEVEL(1-3)
3/5	J. PETTYJOHN	3/2017	-	-	1:24	A



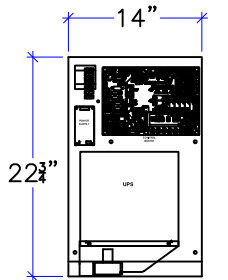
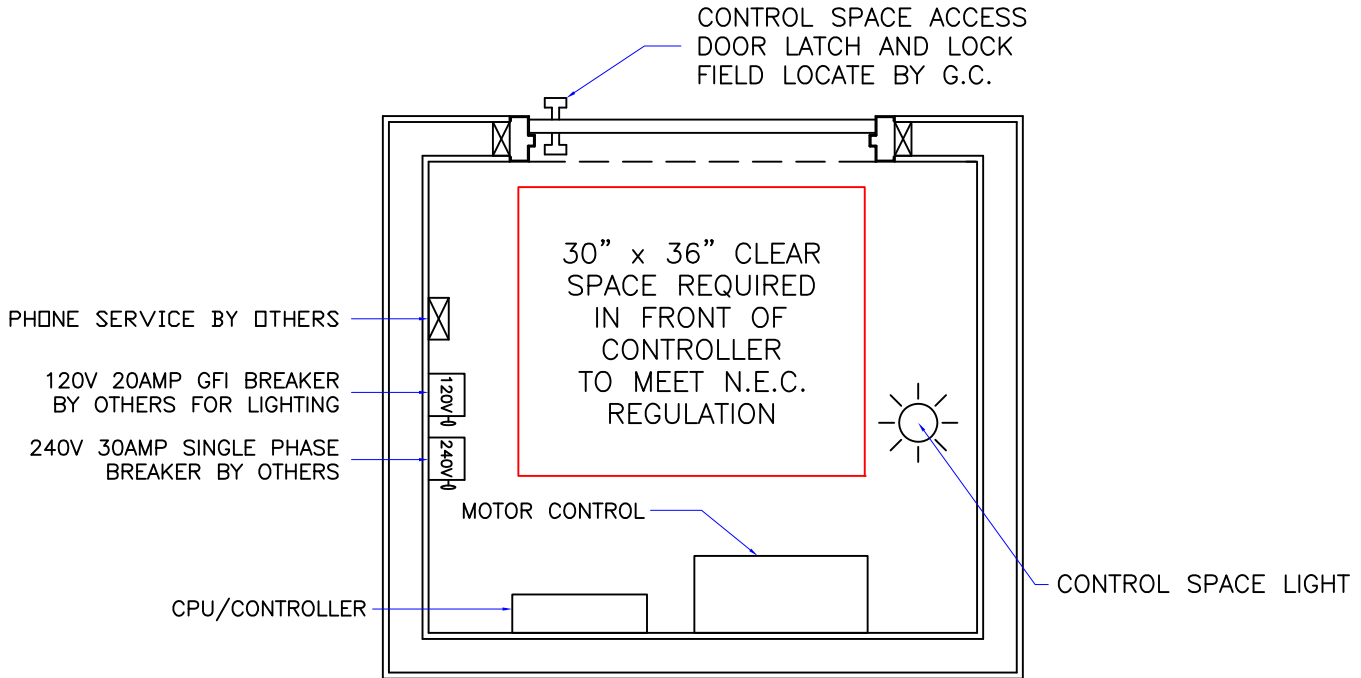

**CPU ENCLOSURE**  
(14"W x 22 3/4"H x 4"D)

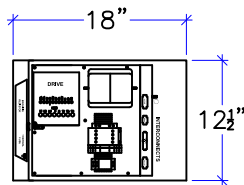

**MOTOR CONTROL ENCLOSURE**  
(18"W x 12 1/2"H x 8"D)

**CONTROLLER SPACE:**

- 1: THE CPU AND MOTOR CONTROL ENCLOSURE SHOULD BE LOCATED IN THE SAME LOCATION. THE RECOMMENDED WIRING DISTANCE FROM THE CPU AND MOTOR CONTROL ENCLOSURE TO THE MOTOR TO BE 10'. LONGER MOTOR CABLES UP TO 50' ARE AVAILABLE. CONSULT WITH INCLINATOR WHEN ORDERING.
- 2: CONTROLLER SHOULD BE MOUNTED IN A TEMPERATURE CONTROLLED ENVIRONMENT BETWEEN 40°F TO 120°F (4°C - 49°C).
- 3: CPU AND MOTOR CONTROL ENCLOSURE SHOULD NOT BE EXPOSED TO OUTDOOR ELEMENTS.
- 4: N.E.C. REGULATIONS REQUIRE A MINIMUM OF 30" WIDE x 36" DEEP x 6'-6" HIGH CLEAR UNOBSTRUCTED SPACE IN FRONT OF CONTROLLER.
5. MACHINE ROOM TO HAVE NATURAL/MECHANICAL VENTILATION IF REQUIRED BY STATE OR LOCAL CODES.
6. MACHINE ROOM LAYOUT MUST COMPLY WITH LOCAL, STATE, AND NATIONAL CODES.

**NOTICE TO ELECTRICAL CONTRACTOR:**

- ALL ELECTRICAL WIRING MUST BE DONE BY A JOURNEYMAN MECHANIC AND MUST MEET ALL NATIONAL, STATE, AND LOCAL CODES.
- BRING (2) #10 W/GND FROM RESIDENCE INCOMING POWER PANEL 30AMP BREAKER (240V, & GROUND) TO THE CONTROLLER SPACE.
- BRING (2) #12 W/GND FROM RESIDENCE INCOMING POWER PANEL 20AMP GFI BREAKER (120V, NEUTRAL, GROUND) TO THE MACHINE ROOM.
- REQUIRED LOW VOLTAGE WIRING IS SUPPLIED BY MANUFACTURER. ALL EXTENSIONS ADDITIONS, ETC. SHALL BE DONE WITH THE SAME SIZE AND TYPE OF WIRE AS ORIGINALLY SUPPLIED BY THE MANUFACTURER.
- A TELEPHONE LINE SHALL BE SUPPLIED TO THE CONTROLLER SPACE AND SHALL BE CONNECTED TO A 24 HOUR CENTRAL EXCHANGE.
- ALL MEANS FOR ACCESS TO EQUIPMENT SHALL BE PROVIDED WITH A LOCK. ALL SHAFT DOORS MUST BE INTERLOCKED.

DWG VIEW		PART NUMBER		REV. DATE		
CONTROLLER SPACE REQUIREMENTS		80205323		-		
DRAWING TITLE		DRAWING NO.		-		
TYPICAL UC601 WD 1000LB		TYP-WD		-		
PAGE:	DRAWN BY:	DWG. DATE	JOB OR APP.#	DEALER P.O.#	DWG. SCALE	REV. LEVEL(1-3)
4/5	S THOMAS	3/2017	-	-	1:24	-



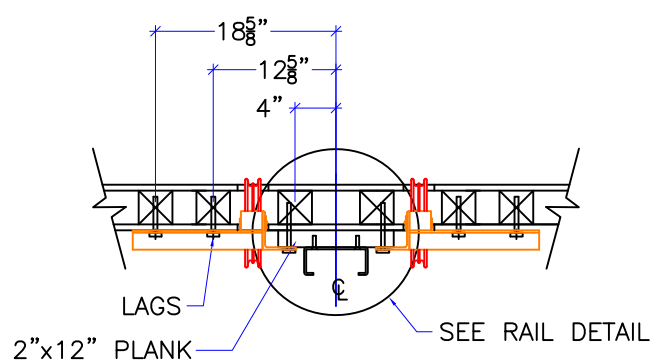
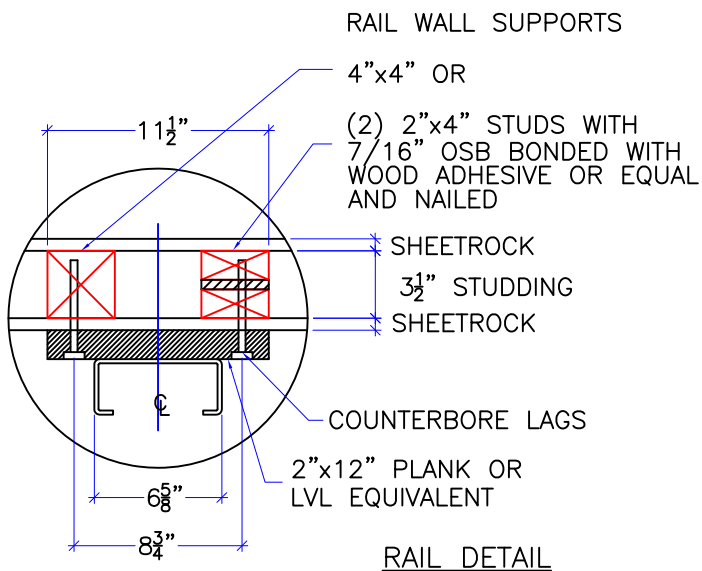

STUD LOCATION FOR THRU THE WALL SHEAVES (IF APPLICABLE)

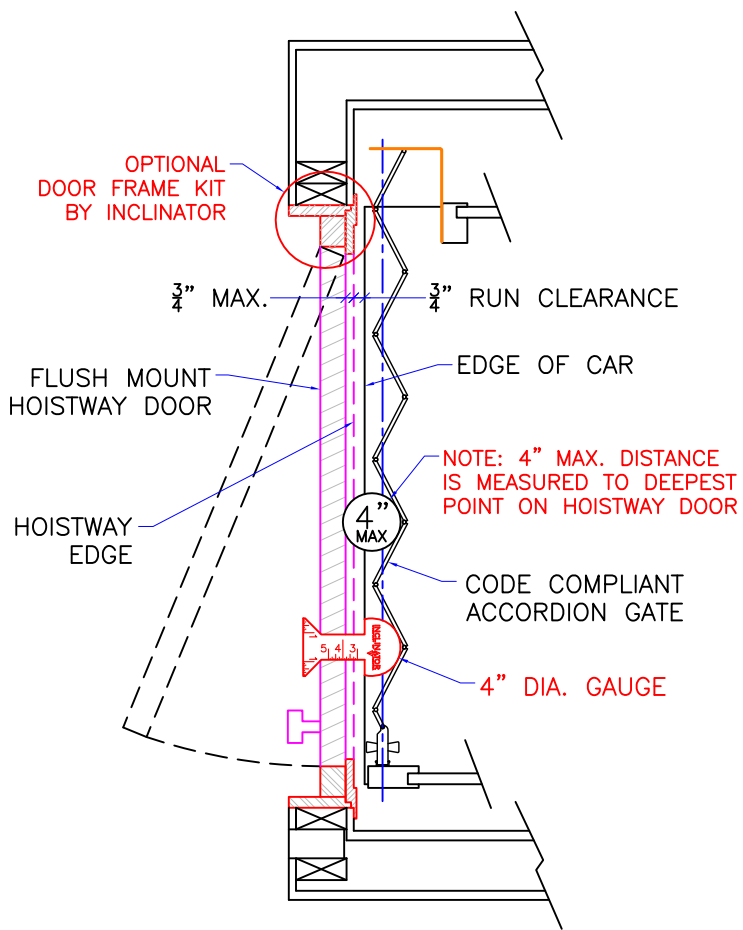

DOOR FRAME DETAILS

REF: ASME 17.1-2016 5.3.1.4.2, 5.3.1.7.2, & 5.3.1.8.3

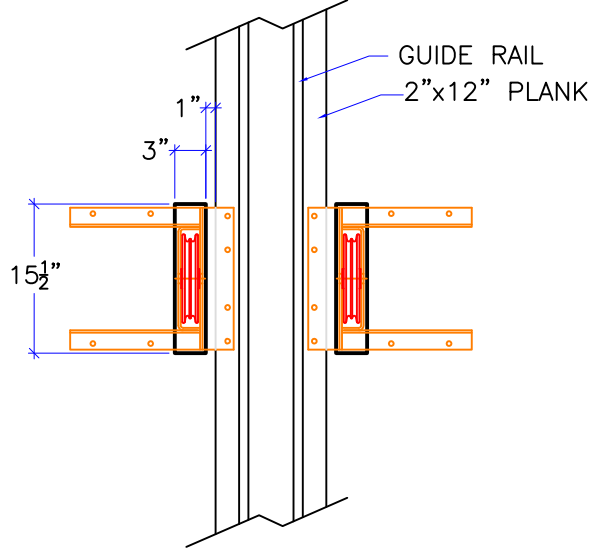

CUTOUT DETAIL (IF APPLICABLE)

1. REACTIONS ON ALL SHEAVES AND MOUNTINGS:  
STATIC = 1,800 LBS.  
IMPACT = 3,600 LBS.
2. FASTENING OF HOISTING MACHINE TO CONCRETE FLOOR:  
MIN. (8) 1/2" ANCHORS, MIN. ULTIMATE STRENGTH OF 5000# EA.
3. RAIL FASTENING TO 2"x12" PLANK:  
#14 x 1 3/4" TYPE A S.M.S. RAIL IS PRE-DRILLED AT FACTORY.
4. BOLT FASTENING OF CAR TO TROLLEY -  
1/2" - 13 x 4" SOCKET HD CAP SCREWS.
5. ALL SHEAVE PITCH DIA. 8 1/8".

TECHNICAL DATA

DWG VIEW		PART NUMBER		REV. DATE		
DETAILS, DATA, CODES		80205323		-		
DRAWING TITLE		DRAWING NO.		-		
TYPICAL UC601 WD 1000LB		TYP-WD		-		
PAGE:	DRAWN BY:	DWG. DATE	JOB OR APP.#	DEALER P.O.#	DWG. SCALE	REV. LEVEL(1-3)
5/5	S THOMAS	3/2017	-	-	1:24	-



SECTION		X - X AXIS						Y - Y AXIS			
MEMBER	WT.	HT.	W	A	I	S	r	Z	I	S	r
		lbs./ft.	in.	in.	in. <sup>2</sup>	in. <sup>4</sup>	in. <sup>3</sup>	in.	in. <sup>4</sup>	in. <sup>3</sup>	in.
SINGLE CHANNEL											
A-1400	1.40	1.625	1.625	.401	.134	.146	.577	.707	.184	.226	.677

LOAD RATINGS FOR 3/8-16 STRUT NUTS USED IN SUPERSTRUT CHANNELS		
CHANNEL NO.	SLIP RESISTANCE LBS.	PULL OUT STRENGTH LBS.
A - 1400	1000	2000

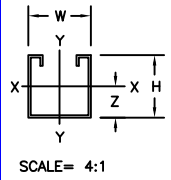

NOMINAL THICKNESS (INCHES)  
 14 GA = .075  
 I - MOMENT OF INERTIA  
 S - SECTION MODULUS  
 r - RADIUS OF GYRATION  
 Z - NEUTRAL AXIS  
 A - AREA

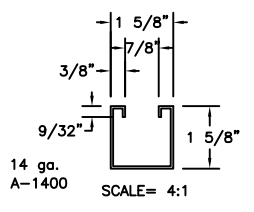
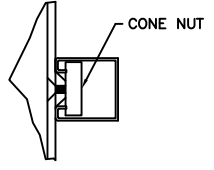

SECTION C-C  
SCALE= 4:1

SUPERSTRUT DETAIL

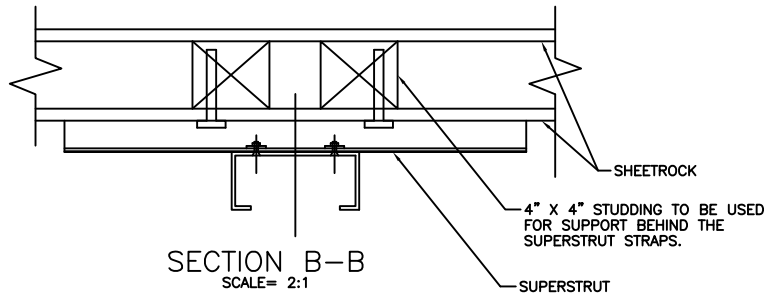

SECTION B-B  
SCALE= 2:1

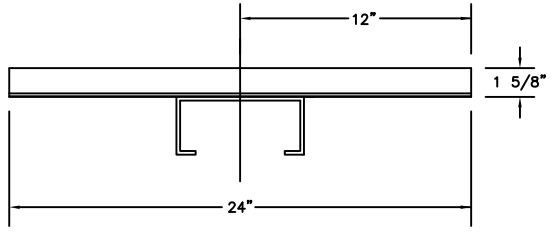

SECTION A-A  
SCALE= 2:1

## MOUNTING TO CONCRETE

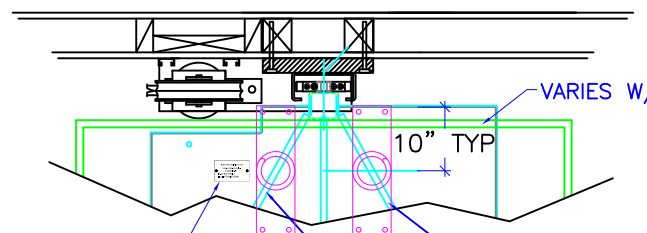
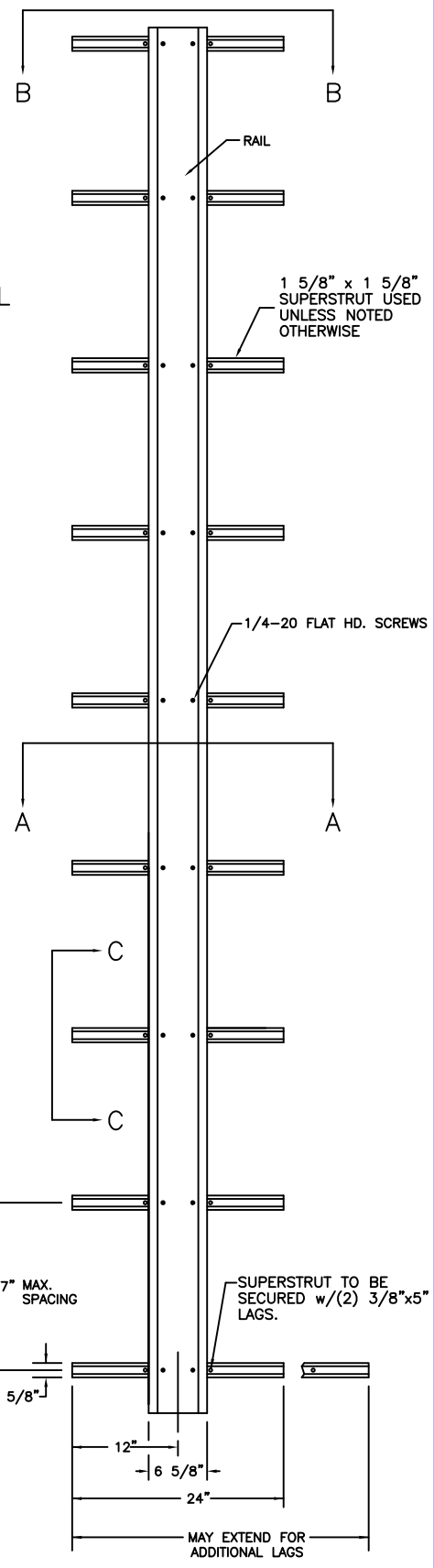

14" MINIMUM PIT FOR BUFFERS

**BUFFER OPTION**  
 MANDATORY WHEN OCCUPIABLE SPACE BELOW ELEVATOR

**SPRING BUFFERS**  
 SPRING WILL DEPRESS 1" AT 373 LBS.  
 (MANUFACTURERS SPECIFICATION)

DWG VIEW				PART NUMBER		REV. DATE	
OPTIONS				80205323		-	
DRAWING TITLE				DRAWING NO.		-	
TYPICAL UC601 WD 1000LB				TYP-WD		-	
PAGE:	DRAWN BY:	DWG. DATE	JOB OR APP.#	DEALER P.O.#	DWG. SCALE	REV. LEVEL(1-3)	
AUX 1	S THOMAS	3/2017	-	-	1:24	-	



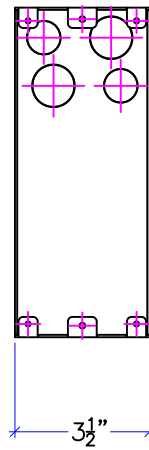
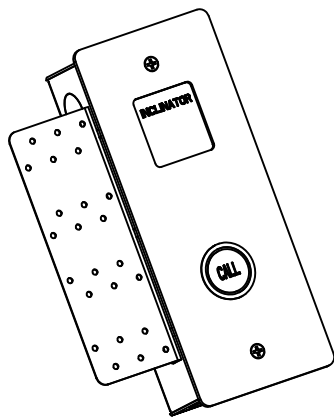

NAIL PLATE MOUNTING BRACKET PROVIDED BY INCLINATOR

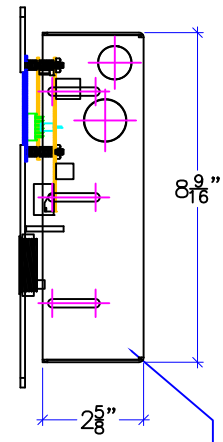

HALL CALL MOUNTING BOX PROVIDED BY INCLINATOR

## FLUSH MOUNT HALL CALL STATION

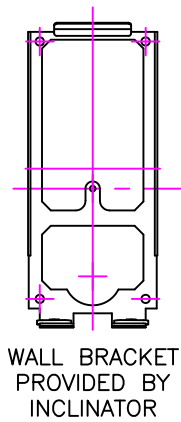
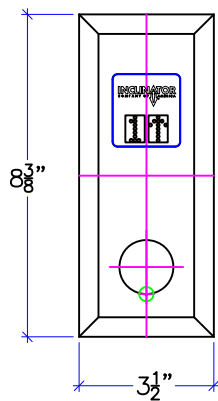
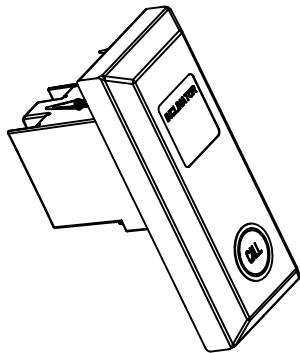

WALL BRACKET PROVIDED BY INCLINATOR

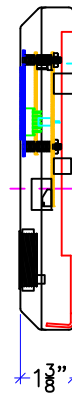

SINGLE GANG MOUNT ELECTRICAL BOX BY OTHERS

THIS HOLE USED TO LOCATE BRACKET OVER GANG BOX

## RAISED MOUNT HALL CALL STATION

DWG VIEW

CALL STATIONS

PART NUMBER

80205323

REV. DATE

DRAWING TITLE

DRAWING NO.

—

TYPICAL UC601 WD 1000LB

TYP-WD

—

PAGE:

DRAWN BY:

DWG. DATE

JOB OR APP.#

DEALER P.O.#

DWG. SCALE

REV. LEVEL(1-3)

AUX 2

S THOMAS

3/2017

—

—

1:24

—



**DOOR FRAME DETAIL**  
 STANDARD 2x4 CONSTRUCTION WITH  
 1/2" DRYWALL (INSIDE & OUTSIDE OF HOISTWAY)



HALLWAY VIEW



HOISTWAY VIEW

DWG VIEW		PART NUMBER		REV. DATE		
DOOR FRAME KITS		80205323		-		
DRAWING TITLE		DRAWING NO.		-		
TYPICAL UC601 WD 1000LB		21211403		-		
PAGE:	DRAWN BY:	DWG. DATE	JOB OR APP.#	DEALER P.O.#	DWG. SCALE	REV. LEVEL(1-3)
AUX 3	S THOMAS	3/2017	-	-	1:24	-

